



VorTek Instruments, LLC
8475 West I-25 Frontage Rd., Suite 300
Longmont, CO 80504
Phone: (303) 682-9999
Fax: (303) 682-4368
www.vortekinst.com

Vortek/TCP Meter Initial Setup

© 2016-17, Vortek Instruments, LLC Rev 1/2018

Table of Contents

POE Wiring.....	2
Network Configuration	4
IPSetup Network Configuration Tool.....	4
Using IPSetup	5
IPSetup Does Not Display Your Vortek/TCP Device	6
IPSetup FAQ.....	6
Meter WEB pages	7
WEB Configuration Interface	11
Connection to meter from the Internet. Security issues.	16
Modbus/TCP interface	18
Modbus utilities.....	18
MBGUI.EXE Simple Modbus/TCP client	20
Console Modbus/TCP client MBUS.EXE	21
Data Logging.....	23
Dummy registers group 9000	28
Other methods of retrieving log files	30
WGET.....	30
FTP	31
Update of Firmware	32



VorTek Instruments, LLC
 8475 West I-25 Frontage Rd., Suite 300
 Longmont, CO 80504
 Phone: (303) 682-9999
 Fax: (303) 682-4368
 www.vortekinst.com

Power Over Ethernet (POE) Wiring Connections

The NEMA 4X enclosure contains an integral wiring compartment with one dual strip terminal block (located in the smaller end of the enclosure). Two 3/4-inch female NPT conduit entries are available for separate power and signal wiring. For all hazardous area installations, make sure to use an agency-approved fitting at each conduit entry. The cable entry device shall be of a certified flameproof type, suitable for the conditions of use and correctly installed. The degree of protection of at least IP66 to EN 60529 is only achieved if certified cable entries are used that are suitable for the application and correctly installed. Unused apertures shall be closed with suitable blanking elements. If conduit seals are used, they must be installed within 18 inches (457 mm) of the enclosure.

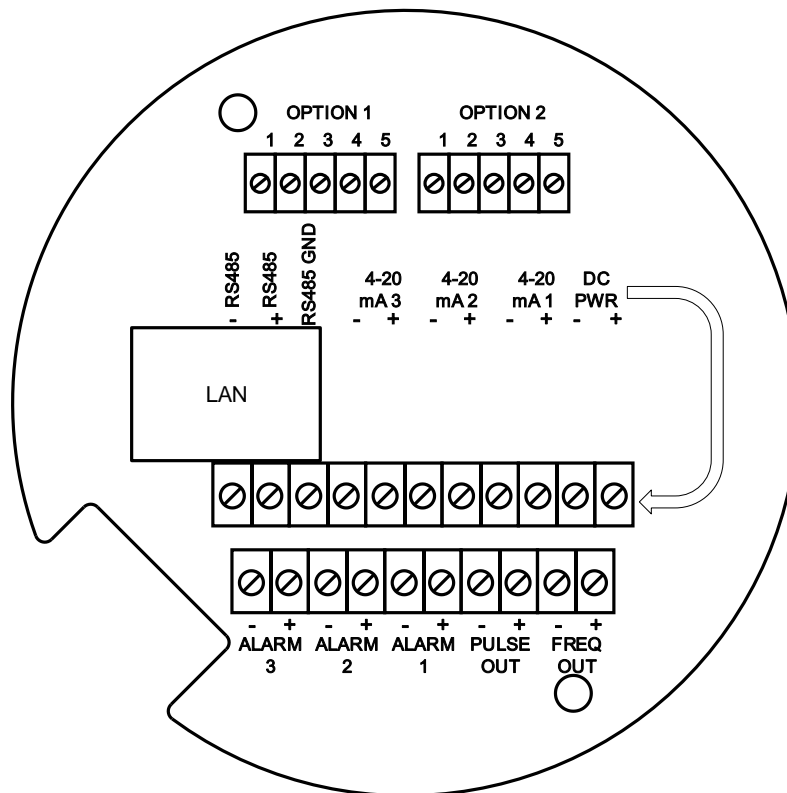

Figure: POE Wiring Terminals

There are two options for powering the POE version meters: DC Power and POE option.



VorTek Instruments, LLC
 8475 West I-25 Frontage Rd., Suite 300
 Longmont, CO 80504
 Phone: (303) 682-9999
 Fax: (303) 682-4368
 www.vortekinst.com



Warning!

Use a Class I or Class II power supply.

A power switch is not provided with this meter, an approved switch meeting the power requirements listed in Appendix A must be provided by the user. It must be easily accessible and marked as the disconnect for the flow meter.

Only the connectors supplied with the meter are to be used for connecting wiring.

If the equipment is used in a manner not specified the protection provided by the equipment may be impaired

DC Power Wiring

The DC power wire size must be 20 to 12 AWG with the wire stripped 1/4 inch (7 mm). Connect 18 to 36 VDC (300 mA, 9 W maximum) to the +DC Pwr and -DC Pwr terminals on the terminal block.

Torque all connections to 4.43 to 5.31 in-lbs (0.5 to 0.6 Nm).

Alternatively POE injector may be used for example: TRENDnet TPE-115Gi

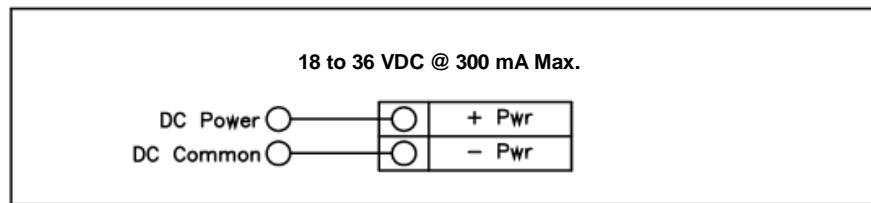

Figure: DC Power Connections



Caution!

The DC wire insulation temperature rating must meet or exceed 85°C (185°F), maximum operating voltage 300 VRMS

Alternatively POE injector may be used for example: TRENDnet TPE-115Gi

POE Power Wiring

Connect the unit with the Ethernet cable to POE enable Ethernet switch (POE option does not require a separate power supply).

Plug Ethernet drop off cable from your Local Area Network (LAN) switch to LAN connector of Vortek meter. You should see a blinking orange LED and a solid green on the front of the LAN connector of the meter henCAT5 Ethernet cable is plugged in and communicating.

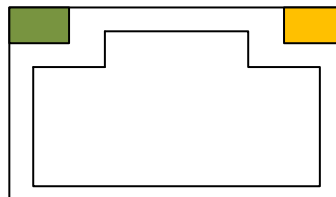

Figure: Front of the LAN connector



VorTek Instruments, LLC
8475 West I-25 Frontage Rd., Suite 300
Longmont, CO 80504
Phone: (303) 682-9999
Fax: (303) 682-4368
www.vortekinst.com

Direct Connection Options

The unit must be powered by one of the above options. If using DC powering option connect a standard ethernet cable to your PC and the unit. If using POE ensure the switch is connected to your PC.

For testing and initial setup purposes, one may use direct connection to PC or Laptop. After reconnecting, you need to cycle the power to the meter. The meter will display the current IP address on the screen. Once the unit is connected it will try to request an IP address from non existent DHCP server and then switch to AutoIP address (unfortunately random), for example 169.254.xxx.xxx.

If you could not see the IP address after cycling the meters power, you can run the IPSetup utility program. See more instructions on how to use the IPSetup program below in Network Configuration. Once you find out assigned meter IP address or the NetBios name <http://VRTXXXXX>, type one of them into a browser to connect to the unit.

Connection issues:

The common issue is that PC does not recognize the plugged Ethernet cable. You maybe require to disable/enable Ethernet adapter to force it to “see” connected cable.

Alternatively, you may use static IP setting for both your PC and meter. The addresses should be on the same network, like 192.168.1.xxx or 10.10.10.xxx

Tip: to quickly find Microsoft Network configuration page, type WindowsKey+R and in command window enter “ncpa.cpl”

Network Configuration

Vortek/TCP meter needs to be configured in order to be “visible” on your local network. There are two methods of configuration:

- Static IP address
- Dynamically assigned IP address via DHCP (Dynamic Host Configuration Protocol).

For static configuration consult your network administrator which IP address to use.

IP Setup Network Configuration Tool:

IPSetup is used to configure network settings on your Vortek/TCP device such as IP Address, Mask, Gateway, DNS Server. If enabled in your device, IPSetup uses a User Datagram Protocol (UDP) broadcast on **port 20034** to identify Vortek/TCP network devices. UDP broadcasts are not forwarded by routers, so IPSetup can only be used on a LAN or direct connection. You need to run it on a PC connected to the same switch as your device.



VorTek Instruments, LLC
8475 West I-25 Frontage Rd., Suite 300
Longmont, CO 80504
Phone: (303) 682-9999
Fax: (303) 682-4368
www.vortekinst.com

IP Setup is commonly used for:

- Determining the DHCP assigned IP address of your device.
- Configuring the network settings of your device.

IPSetup can be downloaded from file system of Vortek/TCP of which may be provided on USB flash drive/CD or available on the Vortek website for download. This program can run on any Windows or Linux machine under Windows emulator WINE.

Configuring the meter with IP Setup:

IPSetup/Configuration should only need to be done at initial commissioning on the customer's network.

Before you begin please ensure the device is on the same LAN or directly connected to a PC.

Click on the IPSetup Icon

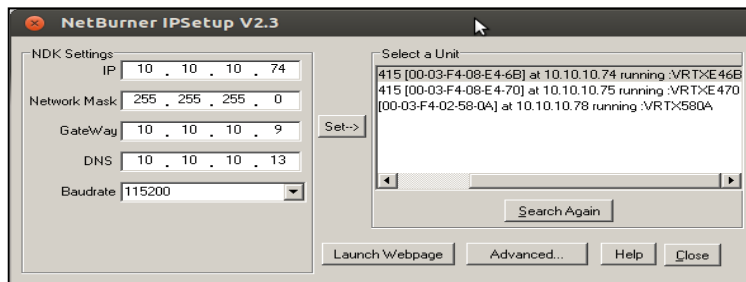

Figure: IPSetup Tool

To configure a device with IPSetup:

- Click on a device in the “Select a Unit” window. Note: each unit has been assigned a unique identifier code that begins with VRTX as seen above. Also, the meter will display the current IP address upon powering up the meter.
- Enter your configuration settings in the “NDK Settings” group. Configuration can either be set up as a static IP address assigned by your network administrator or can be set up to DHCP by setting the IP address to 0.0.0.0.
- Once you have specified all your configuration settings, click on the “Set” button to transmit them to your device. **Please Note: Besides IP, Network Mask, GateWay and DNS, do not change any other parameters, such as Uart, delay, baud rate, etc. Correct GateWay settings are necessary if you are planning to access device from the Internet or other subnets of your local network.**
- The DHCP assigned address, or static IP address, will appear in the description next to each Vortek/TCP device in the Select a Unit window.



VorTek Instruments, LLC
8475 West I-25 Frontage Rd., Suite 300
Longmont, CO 80504
Phone: (303) 682-9999
Fax: (303) 682-4368
www.vortekinst.com

IPSetup Does Not Display Your Vortek/TCP Device

If IPSetup does not display your device, the issue could be one of the following:

- A firewall on your PC is blocking network port number 20034. Try temporarily disabling your firewall and try again.
- If you are trying to talk to a device on the other side of a router. Check to see if the PC and Vortek/TCP devices are on the same LAN.

IPSetup FAQ

- If DHCP serve can't assign an address to the meter, it will switch to AutoIP. AutoIPs are special addresses in the range 169.254.XXX.XXX. The XXX.XXX values are randomly selected with an attempt to avoid duplication. AutoIP is used for DIRECT CONNECTION to a PC.
- IPSetup shows the name of the application as shown on Fig. below. The name is composed of letters VRTX and 4 last HEX digits of unit's MAC address. For example: VRTXE46B also referred to as the NetBios name.

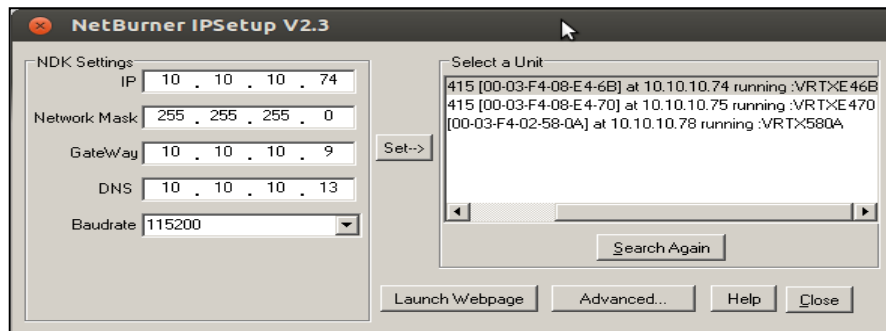

Figure: IPSetup displaying the unique identifier code VRTX (netbios name).

- You may access the unit by typing the name in address field of WEB browser, for example: <http://VRTXE46B>. This works on Microsoft computers and may not work on Linux machines. For Linux machines it needs to have SMB protocol enabled to understand the NetBios names. *Tip: there is linux nmblookup command, which shows IP address by NetBios name.*
- It is recommended to provide a correct GateWay address. DNS is necessary only if access to the Internet is needed for the device. in case, for example, accessing Network Time Servers. It may be set as 0.0.0.0.



VorTek Instruments, LLC
 8475 West I-25 Frontage Rd., Suite 300
 Longmont, CO 80504
 Phone: (303) 682-9999
 Fax: (303) 682-4368
 www.vortekinst.com

Meter WEB pages

VRTX meter has an internal WEB server providing real time measurement information and a configuration interface.

The meter supports two protocols for accessing the WEB pages:

- HTTP – insecure connection to TCP port 80
- HTTPS – secure connection to configuration pages on TCP port 443.

It is possible to connect to all pages using HTTPS instead of HTTP. The assumption is that measurement data does not need to be secure, while configuration must be always encrypted.

WEB page

VorTek Flowmeter

HOME
 FLOW
 METER
 FLUID
 DIAGNOSTIC
 CONFIGURE
 DATA LOG
 Startup Log

Copyright © 2014-2017
 VorTek Instruments.

A Leader in Precision Multivariable Flowmeters for the Measurement of Liquid, Gas, Steam, and Energy.

For more information about Vortek Instruments and its products visit <http://www.vortekinst.com>.

Discovered Vortex Meters:

Addr:	Serial Number	HW	FW	Sig.Rev	OEM
1	2	24	78.2	3.14	6

BACnet/IP enabled

Uptime: 28 days 01:16:45

Meter RTC: 11/29/2017 12:45:20

Networking Data: MAC:00:03:F4:0A:1D:37, NETBIOS Name:VRTXID37
 My IP:10.10.10.75
 SD Free size:7,854,587,904

Transmissions: 3695944 Errors:0

Figure: Main/home page

Above is a Figure of the main page of the webpage with the menu selections on the left side. When the meter is initially powered up, it scans for connected meters. This version is intended for master/slave configuration with multiple meters connected to a single gateway. Normally this Slave Address selector is not used and there is always only one selection possible.



VorTek Instruments, LLC
 8475 West I-25 Frontage Rd., Suite 300
 Longmont, CO 80504
 Phone: (303) 682-9999
 Fax: (303) 682-4368
 www.vortekinst.com

VorTek Flowmeter Flow Parameters

Flowmeter WEB Interface		VRTX_1.15.9_B	
Flow Values			
Mass Flow	418.14	lb/hr	
Volume Flow	20010.4	gal/hr	
Pressure	24397.2	mmHzO @4 °C (A)	
Temperature 1	529.67	°R	
Fluid Density	0.126	lbm/in ³	
Fluid Viscosity	0.00171		
Flow Totalizer	1303603	lb	
Flow Total Qty per Pulse	1000		

Copyright © 2014-2017
 VorTek Instruments.

Figure: Flow

The above Figure display what values are available on the Flow menu.

VorTek Flowmeter Meter Configuration

Calling IP	10.10.10.131	
Device IP	10.10.10.75	
Uptime	28 days 02:00:23	
Meter RTC	11/29/2017 13:28:58	
Meter Configuration		
Meter Index	2	inch
Meter K-Factor	269.159	P·ft ³
Insertion Pipe ID	1.939	inch
Insertion Base K	269.159	P·ft ³
Insertion Base Re	0	
Low Flow Cutoff	10	
Vortex Coefficient Ck	5	
Press Coefficient B00	-1.96404	
Press Coefficient B01	-2.39886	
Press Coefficient B02	0.196427	
Press Coefficient B10	1057.53	
Press Coefficient B11	362.476	
Press Coefficient B12	-227.993	
Press Coefficient B20	-1115.91	
Press Coefficient B21	1205.24	
Press Coefficient B22	-357.796	
Meter Diagnostic		
Faults	0	
NV Faults	0	
ADC_Counts[0]	89	
ADC_Counts[1]	14	
ADC_Counts[2]	9	
ADC_Counts[3]	4	
Analog OutCount[0]	2637	
Analog OutCount[1]	2637	
Analog OutCount[2]	2637	
Exceptions	131	

Copyright © 2014-2017
 VorTek Instruments.

Figure: Meter

The above Figure display what values are available in the Meter menu.



VorTek Instruments, LLC
 8475 West I-25 Frontage Rd., Suite 300
 Longmont, CO 80504
 Phone: (303) 682-9999
 Fax: (303) 682-4368
 www.vortekinst.com

Fluid Parameters		
Calling IP	10.10.10.131	
Device IP	10.10.10.75	
Uptime	28 days 02:34:16	
Fluid Configuration		
Fluid Type	Real Gas	
Real Liquid Type	Water	
Real Gas Type	Steam	
Other Liquid Density	0.0360937	
Other Liquid AL	1	
Other Liquid BL	0	
Goyal Mole Weight	32.042	
Goyal Critical Press	1174.2	psia
Goyal Critical Temperature	463	°R
Goyal Critical Z	0.224	
Goyal AL	1	
Goyal BL	1	
API Density	1	kg/m ³
Api K0	1	
API K1	1	
Api AL	0.00072	
API BL	5215	
Nat. Gas Specific Gravity	0.6	
Nat. Gas Mole Fract. N ₂	0.02	
Nat. Gas Mole Fract. CO ₂	0.01	
Nat. Gas Ref. Temp.	518.67	°F
Nat. Gas Ref. Pressure	10335.4	psia
Other Gas Specific Gravity	1	
Other Gas Comp. Z	1	
Other Gas Viscosity	0.01	cP
Fluid Standard Temperature	59	°F
Fluid Standard Pressure	14.6959	psia
Fluid Normal Temperature	0	°C
Fluid Normal Pressure	101.325	kPa
Liquid Gas Type	CO ₂	
Thermal Oil Type	DowTherm A	
Steam Standard Temperature	0	°F
Steam Standard Pressure	32.042	psia
Steam Normal Temperature	1174.2	°C
Steam Normal Pressure	463	kPa

Figure: Fluid

The above Figure displays the values of the Fluid menu.



VorTek Instruments, LLC
8475 West I-25 Frontage Rd., Suite 300
Longmont, CO 80504
Phone: (303) 682-9999
Fax: (303) 682-4368
www.vortekinst.com

Meter Diagnostic Details		
Calling IP	10.10.10.131	
Device IP	10.10.10.75	
Uptime	28 days 02:54:50	
Diagnostic		
Shedding Frequency	200	Hz
Filter Frequency	38.6415	Hz
Fluid Velocity	36.2358	Hz
Reynolds Number	133217	
Temp. Compensated K-Factor	269.159	P.ft ³
RTD1 Resistance	1100.12	Ohms
Insertion Local K	269.159	P.ft
Scaled Output Frequency	0	Hz
Maximum Velocity	36.2358	ft/s
Maximum Fluid Temperature	544.652	°R
Maximum Pressure	5121.42	mmH ₂ O @4 °C (A)
Amplitude (Vrms)	0.000109947	Vrms
Electronics Temperature	549.703	°R
Maximum Electronics Temperature	557.542	°R
Minimum Electronics Temperature	532.266	°R
Hourly Flow	417.61	
Obscuration	0.870719	
Profile Factor	0	
Insertion	0.9695	
Pipe Area	2.95288	
Glycol Weight %	32.3415	
External Loop mA	0	mA

Figure: Diagnostics

The above Figure shows the values of the Diagnostics menu.

In order to get access to Configuration page, you need to connect via HTTPS

Please, reconnect using HTTPS

[Click here if you are on the local network](#)

[Click here if you are on the local network and reopen in this frame](#)

[Click here if you are on the Internet via port forward as: meter.vortekinst.com](#)

[Click to open meter.vortekinst.com in this frame](#)

Otherwise you have to reconnect to the configuration page as https://your_ip/CONFMENU.HTML or https://your_ip - connect to ALL pages via https

There may be problems with some versions of Internet Explorer. (e.g. IE10)
 If IE does not show on "problem page" the link: "Continue to this website(not recommended)", either update IE to Rev. 11 or better use different browser, such as Firefox or Chrome.

Figure: Configuration

The above Figure shows the Configuration page options.



VorTek Instruments, LLC
8475 West I-25 Frontage Rd., Suite 300
Longmont, CO 80504
Phone: (303) 682-9999
Fax: (303) 682-4368
www.vortekinst.com

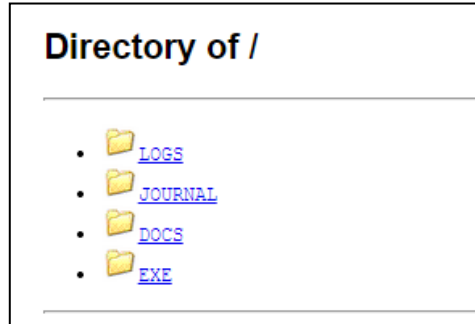

Figure: Data log

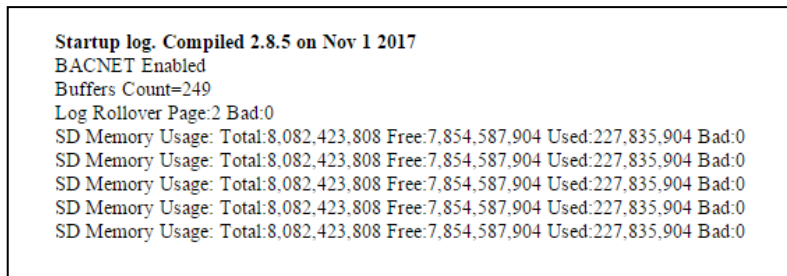

Figure: Startup log

WEB Configuration Interface

Clicking on CONFIGURE Menu link opens the following page

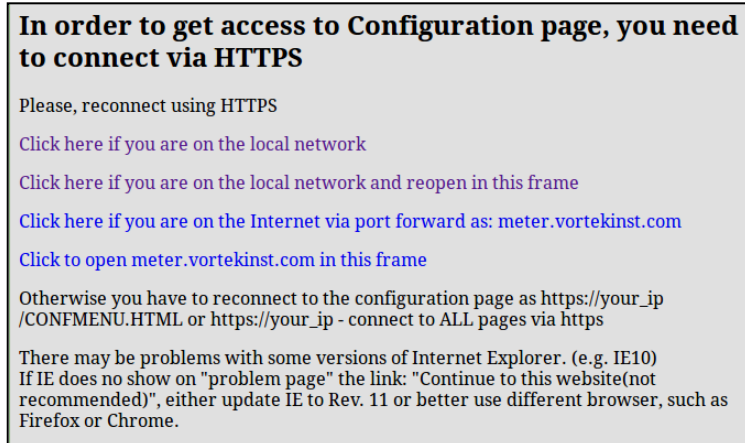

Figure: Configuration



VorTek Instruments, LLC
8475 West I-25 Frontage Rd., Suite 300
Longmont, CO 80504
Phone: (303) 682-9999
Fax: (303) 682-4368
www.vortekinst.com

Connection to the Configuration interface is done using encrypted protocol HTTPS. When connected for the first time, your browser and the unit need to perform a verification. This process is slightly different in different browsers. For the initial set up of the webpage please click the link “Click here if you are on the local network”. Below is an example of the browser FireFox:

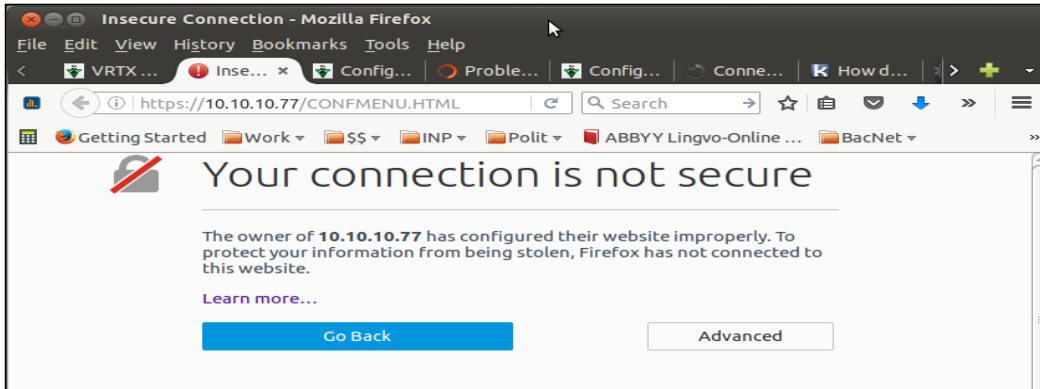

Figure: Fire Fox Verification Page

Please click the “Advanced” button. Once the advanced button is selected the next page is shown with the button “Add Exception” at the bottom.

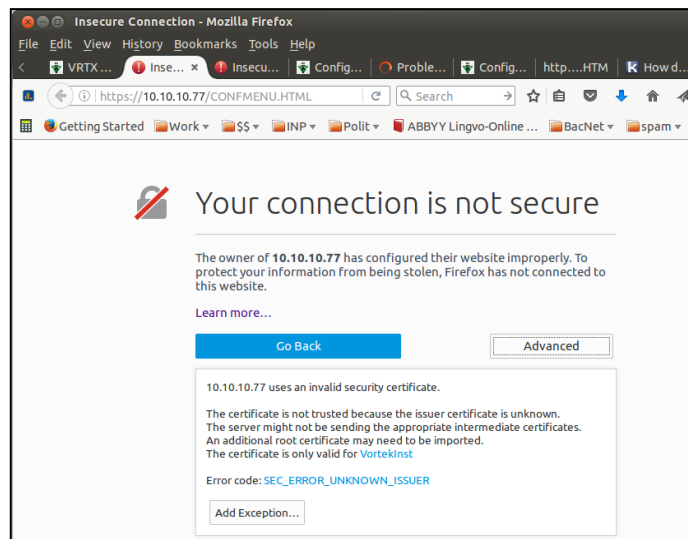

Figure: Fire Fox Add Exception



VorTek Instruments, LLC
8475 West I-25 Frontage Rd., Suite 300
Longmont, CO 80504
Phone: (303) 682-9999
Fax: (303) 682-4368
www.vortekinst.com

Note: If you selected the link “[Click here if you are on the local network and reopen in this frame](#)”, the browser will not have the “Add Exception” button. We recommend using the first link when connecting to the new unit for the first time. After the initial setup, you may find it more convenient to use the second link and open configuration interface inside the frame.

By clicking “Add Exception” the following screen is opened:



Figure: FireFox Add Security Exception

The browsers issue with the VortekInst certificate is that it is an IP address instead of a site name like myBank.org. You may view the certificate by clicking “Confirm Security Exception” and this certificate will be stored in your browser. The next time the browser knows which certificate to use for this IP. If you change the IP address of the meter, you'll need to go through this procedure again.



VorTek Instruments, LLC
8475 West I-25 Frontage Rd., Suite 300
Longmont, CO 80504
Phone: (303) 682-9999
Fax: (303) 682-4368
www.vortekinst.com

With other browsers, the procedure may be slightly different. However, you will need to repeat the steps to confirm the certificate for each browser.

On Windows IE Explorer the browser will show page as shown below.

You need to click the link “Continue to this website (not recommended)”. In some versions of IE it may not show this link. In such case upgrade IE to version 11 or better user different browser, e.g. Firefox.

Internet Explorer HTTPS warning page.

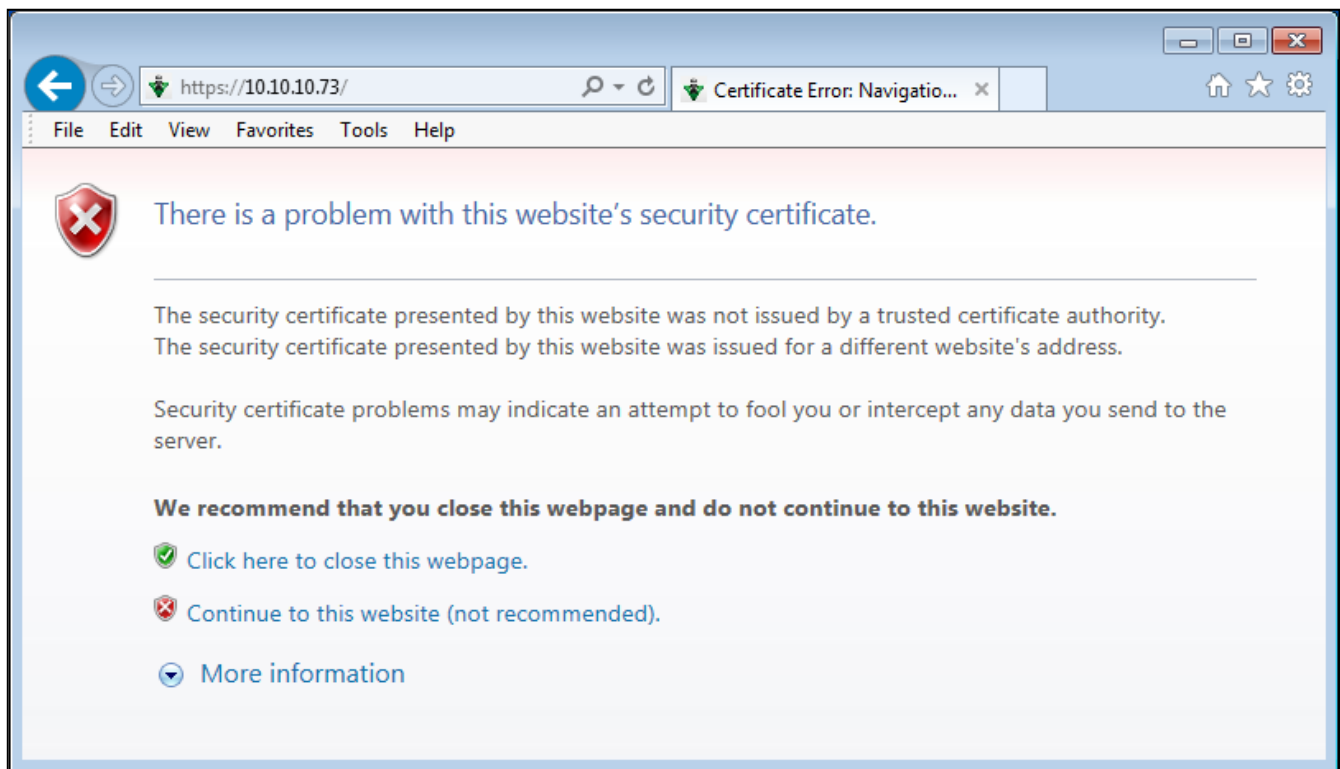

Figure: Internet Explorer Warning Page

After certificate acceptance is done you may enter the configuration page. It will ask for authentication.

- User Name: creator
- Password: 16363



VorTek Instruments, LLC
8475 West I-25 Frontage Rd., Suite 300
Longmont, CO 80504
Phone: (303) 682-9999
Fax: (303) 682-4368
www.vortekinst.com

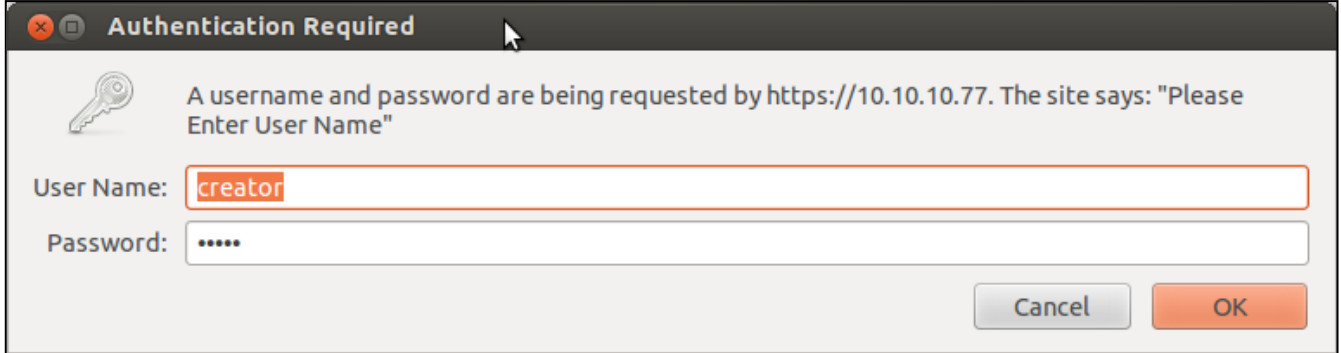

Figure: Authentication Required

It will show configuration page in full screen or in frame if second link is used.

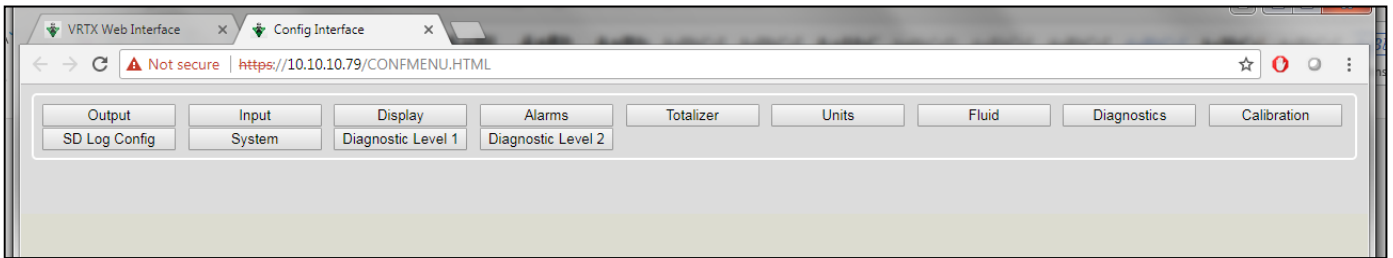

Figure: Configuration Interface New Tab

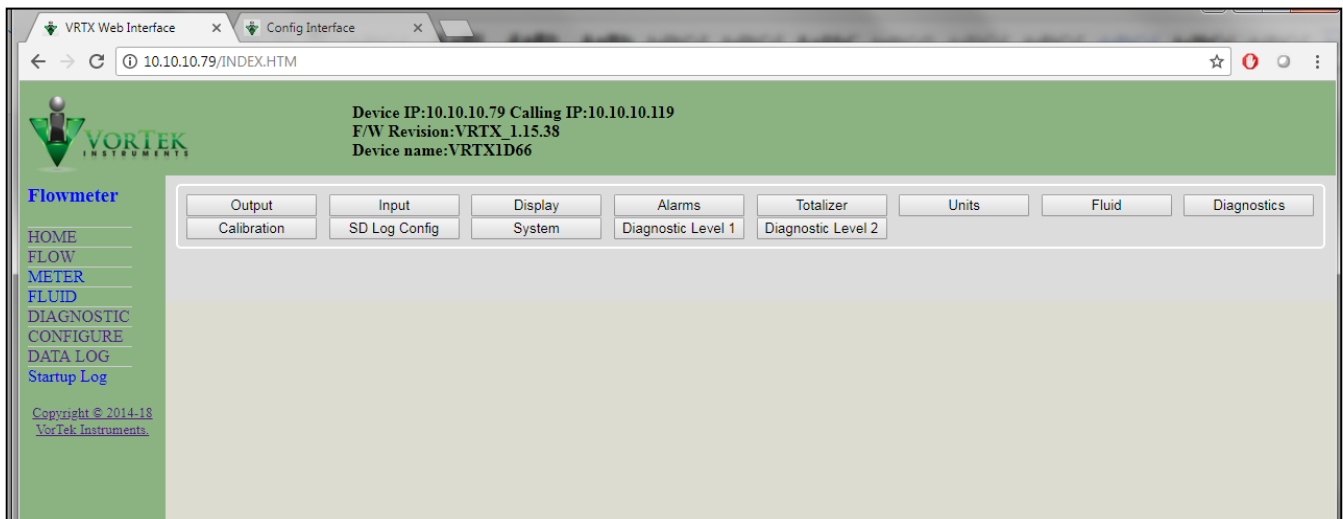

Figure: Configuration Interface In Frame



VorTek Instruments, LLC
8475 West I-25 Frontage Rd., Suite 300
Longmont, CO 80504
Phone: (303) 682-9999
Fax: (303) 682-4368
www.vortekinst.com

Internet connection to the meter, security issues.

Typically the meter is connected to the Local Area Network (LAN) with non-routable Private Network Address (192.168.xx.xx, 10.xx.xx.xx, 172.16-31.xx.xx). There are two options to setup the meter from the Internet:

- Connect via Virtual Private Network (VPN)
- Port Forwarding technique.

In case of VPN, your home PC becomes part of your corporate network which will allow access to all resources on the corporate LAN. Usually, your home PC is assigned an IP address from a different subnet than the meters. Therefore, the IPSetup program may not function correctly. You will need to know the specific IP address of the meter in order to connect. Please contact your IT department about availability of VPN and connection instructions.

Second method of Port Forwarding is configuring the corporate firewall to allow you access to certain internal (LAN) IP address by mapping it to your external corporate gateway IP and port number. This is usually done by mapping. See the following for an example. Assuming your corporate gateway is 50.202.79.132 and your meter IP on LAN is 10.10.10.75.

Example of port forwarding:

External IP 50.202.79.132 Port 8080 =====>mapped to=====> 10.10.10.75 Port 80

External IP 50.202.79.132 Port 10502 =====>mapped to=====> 10.10.10.75 Port 502

External IP 50.202.79.132 Port 10443 =====>mapped to=====> 10.10.10.75 Port 443

Please contact your IT department for configuration on corporate routers. They will need the following information on the used network port:

TCP port 80 Non-secure access to main WEB pages. Read only. Protocol HTTP. It is also possible to access meter using only secure connection via Port 443.

TCP port 443 Secure encrypted access to configuration pages. Protocol HTTPS, SSL.
Encryption 128 bit – does not require Export licensing.
User/password protected (secure)

TCP port 502 Access by automation software to Modbus/TCP server. Protocol Modbus/TCP

Optional: TCP ports 20,21- Access to internal FTP server. Protocol FTP. User/password protected (insecure)



VorTek Instruments, LLC
8475 West I-25 Frontage Rd., Suite 300
Longmont, CO 80504
Phone: (303) 682-9999
Fax: (303) 682-4368
www.vortekinst.com

UDP port 20034 Broadcast discover protocol. Used to find units on the local Network.
It is not routable and therefore works only within the same subnet.
Used by IPSetup (discover/IP config) and AutoUpdate (flash) programs.
AutoUpdate works across Ethernet switches. It uses UDP with direct address.
It may be blocked by most routers.

TCP port 20034- Firmware update using TcpUpdate utility. (Not enabled in Rev 1.0 of firmware).

Corporate gateways can have additional security enhancing measures, like sourcing. Sourcing addresses only allows access from certain individual IPs or networks. If security concerns are an issue, you may limit access to the meter using encrypted protocol only: port 443, https. On special request VortekInst can add special capability of Access Control List (ACL) to insecure by definition Modbus protocol. Using ACL user may define number of hosts or networks from which connection to Modbus port 502 can be accepted. Normally this function can be implemented in corporate firewall. ACL in meter may be needed when it is exposed to the Internet directly.

General information about Port Forwarding and instructions how to set up it in simple home routers available everywhere. E.g. here: <http://www.howtogeek.com/66214/how-to-forward-ports-on-your-router/>



VorTek Instruments, LLC
8475 West I-25 Frontage Rd., Suite 300
Longmont, CO 80504
Phone: (303) 682-9999
Fax: (303) 682-4368
www.vortekinst.com

Modbus/TCP interface

Vorteks TCP meter supports industry standard automation protocol Modbus/TCP.

General specifications:

Protocol	TCP
Port	502
Number of simultaneous connections	20
Format of 16 bit registers	standard MSB first (big endian)
Format of 32 Long and Float values	Most significant word coming first (big endian)
Modbus Address	0
Supported Function Codes	3,4,16,5

Modbus utilities

We include for customer convenience two applications which may be used during integration into your automation system:

- MbusGui.exe Windows GUI application for reading Modbus registers of the meter.
- mbus.exe Generic DOS console application for reading Modbus/TCP registers.

These two applications are stored on SD card inside meter. To download them click on menu link "LOG DATA" and then select directory EXE. Right click on MBUS.EXE or MBGUI.EXE link to download it to your PC.



VorTek Instruments, LLC
8475 West I-25 Frontage Rd., Suite 300
Longmont, CO 80504
Phone: (303) 682-9999
Fax: (303) 682-4368
www.vortekinst.com

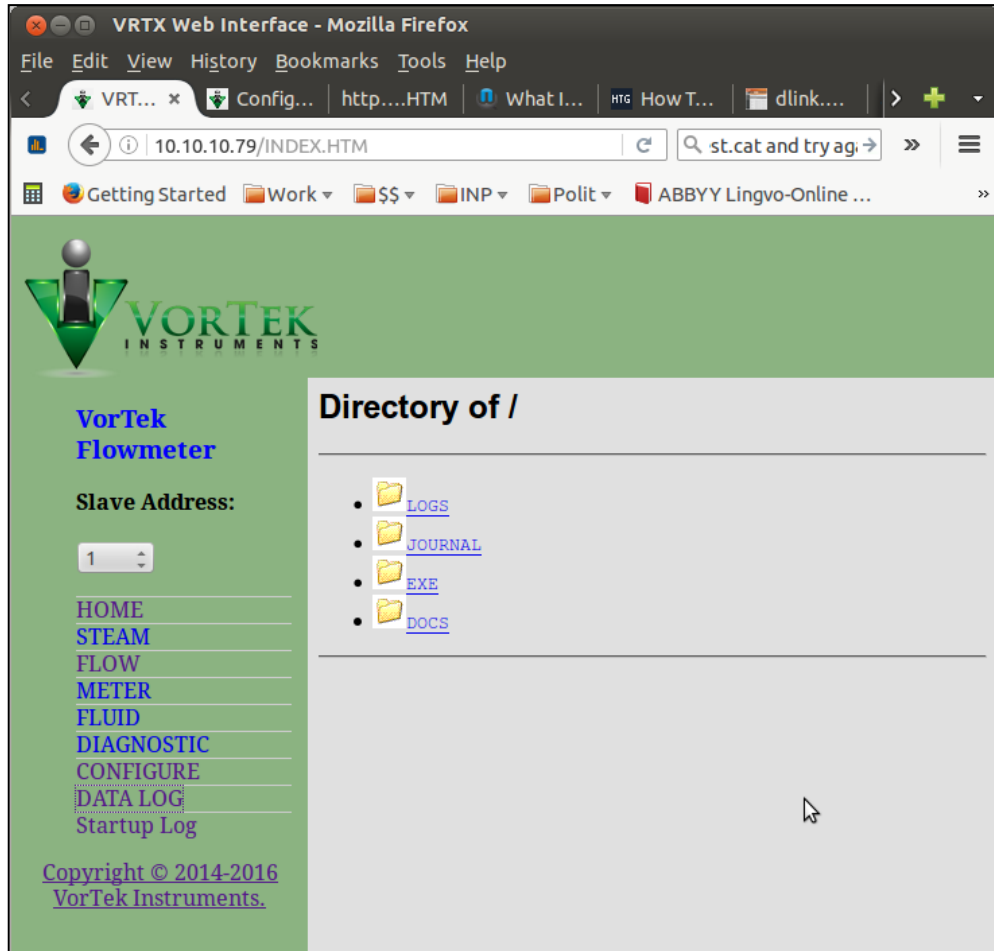

Figure: EXE Folder



VorTek Instruments, LLC
 8475 West I-25 Frontage Rd., Suite 300
 Longmont, CO 80504
 Phone: (303) 682-9999
 Fax: (303) 682-4368
 www.vortekinst.com

MBGUI.EXE Simple Modbus/TCP client

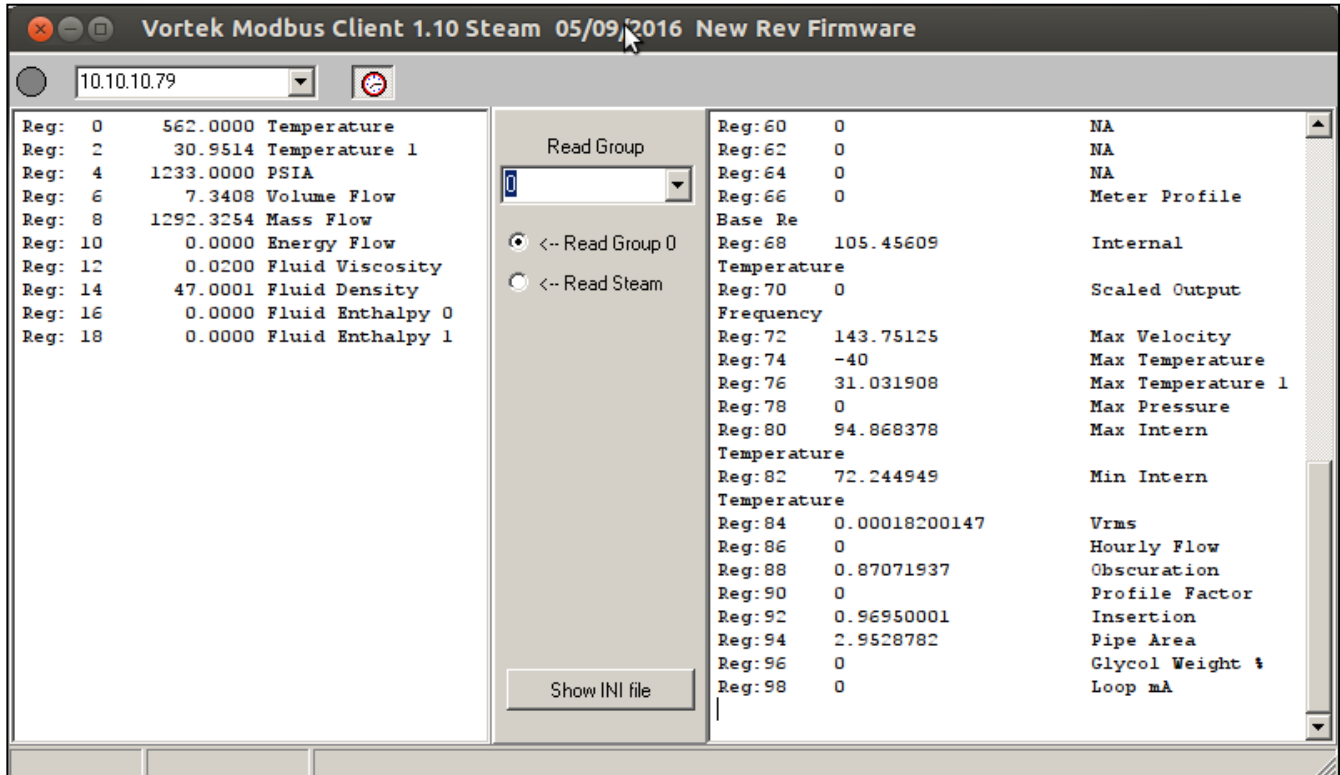

Figure: MBGUI.EXE Interface

This is a simple Modbus/TCP client configured for use with VRTX/TCP meter. The names and location of registers are stored in mbgui.ini file. This file is created at start up and contains default definitions. The structure of the application uses the following approach accepted for Vortek's meters supporting Modbus/RTU. All registers are grouped by data types: float, long, etc. Two groups of Vortex registers 0 containing most of real time data and Group 200 – containing steam-related data can be viewed on a timer once in two seconds on the left panel. Selecting a group in "Read Group" selector will show it in right panel. You can rename the application to something more meaningful for you (please avoid spaces in program name). In this case it will rename accordingly the INI file. By this you may create several clients for different meters.

This application is compiled to run on Windows machine. It also can be run on Linux or MAC machine with 586 architecture under Windows emulator WINE. (MAC case was not tested).



VorTek Instruments, LLC
8475 West I-25 Frontage Rd., Suite 300
Longmont, CO 80504
Phone: (303) 682-9999
Fax: (303) 682-4368
www.vortekinst.com

Console Modbus/TCP client MBUS.EXE

This is simple Modbus/TCP client for reading Modbus registers and output data in specified format. It can be used for creating automation scripts in any scripting language, like bash, LabView, MatLab, DOS batch, etc.

Open in DOS window directory where you put the executable MBUS.EXE

A screenshot of a terminal window titled 'georgi@gp: ~'. The window has a dark background and a light-colored text. The terminal shows the command './MBUS.EXE -h' being executed, which outputs the following text:

```
georgi@gp:~$ ./MBUS.EXE -h
Modbus client 1.4
usage: mbus ip_adrs unit reg_no num_regs [format_string]
  mbus 172.20.1.24 0 0 10
  mbus 172.20.1.24 0 206 5 ili
options:
  -p port [502]
  -I invert long data
  -f function code (supported 3,4 default - 3)
format specifiers:
  a - ascii, b[B] - byte, i[I] - int16, l[L] - int32, f - float,
  h - hex (16), H - hex (32), t - time(ms)
  , B,L,I - for unsigned
  format multipliers like i20a10 are OK
georgi@gp:~$
```

Figure: MBUS.exe

There is minimal help shown by command:

MBUS.EXE -h

It can read arbitrary Modbus registers. The only limitation it supports only “classic” order of bytes in 16 bit registers: big endian.

Examples:



VorTek Instruments, LLC
8475 West I-25 Frontage Rd., Suite 300
Longmont, CO 80504
Phone: (303) 682-9999
Fax: (303) 682-4368
www.vortekinst.com

```
georgi@gp: ~
File Edit View Search Terminal Help
georgi@gp:~$ ./MBUS.EXE 10.10.10.79 -I 0 0 6 fff
562.000000, 30.943373, 1233.000000
georgi@gp:~$ ./MBUS.EXE 10.10.10.79 -I 0 0 6 f3
562.000000, 30.947727, 1233.000000
georgi@gp:~$ ./MBUS.EXE 10.10.10.79 -I 0 1002 4 i4
158, 22, 6, 1
georgi@gp:~$
```

Figure: MBUS.exe example

Read first 6 registers from group 0 and display as Float. Each “f” in first example corresponds for each read register or register pair for float. “fff” may be replaced by “f3”

Switch “-I” telling that float format is inverted: MSW coming first. This option should always be used with Vortex Meter. Line 3 reads 4 short integer registers from reg number 1002 and output as 16 bit integer.

For debug purpose during integration you may format output as HEX

```
georgi@gp: ~
File Edit View Search Terminal Help
georgi@gp:~$
georgi@gp:~$
georgi@gp:~$ ./MBUS.EXE 10.10.10.79 -I 0 1002 4 i4
109, 18, 6, 1
georgi@gp:~$ ./MBUS.EXE 10.10.10.79 -I 0 1002 4 hhhh
0x006D, 0x0012, 0x0006, 0x0001
georgi@gp:~$
```

Figure MBUS.exe Hex example



VorTek Instruments, LLC
8475 West I-25 Frontage Rd., Suite 300
Longmont, CO 80504
Phone: (303) 682-9999
Fax: (303) 682-4368
www.vortekinst.com

Data Logging

VRTX/TCP meter has internal logging capability. The data is logged to micro SD card inside unit. The capacity of SD card may vary from 4 to 32 GB. The size of card and free space are shown on StartUp Log page. Card is formatted as FAT32 with long file name disabled. All file names are in 8.3 format. To access the log files, click menu link “DATA LOG”

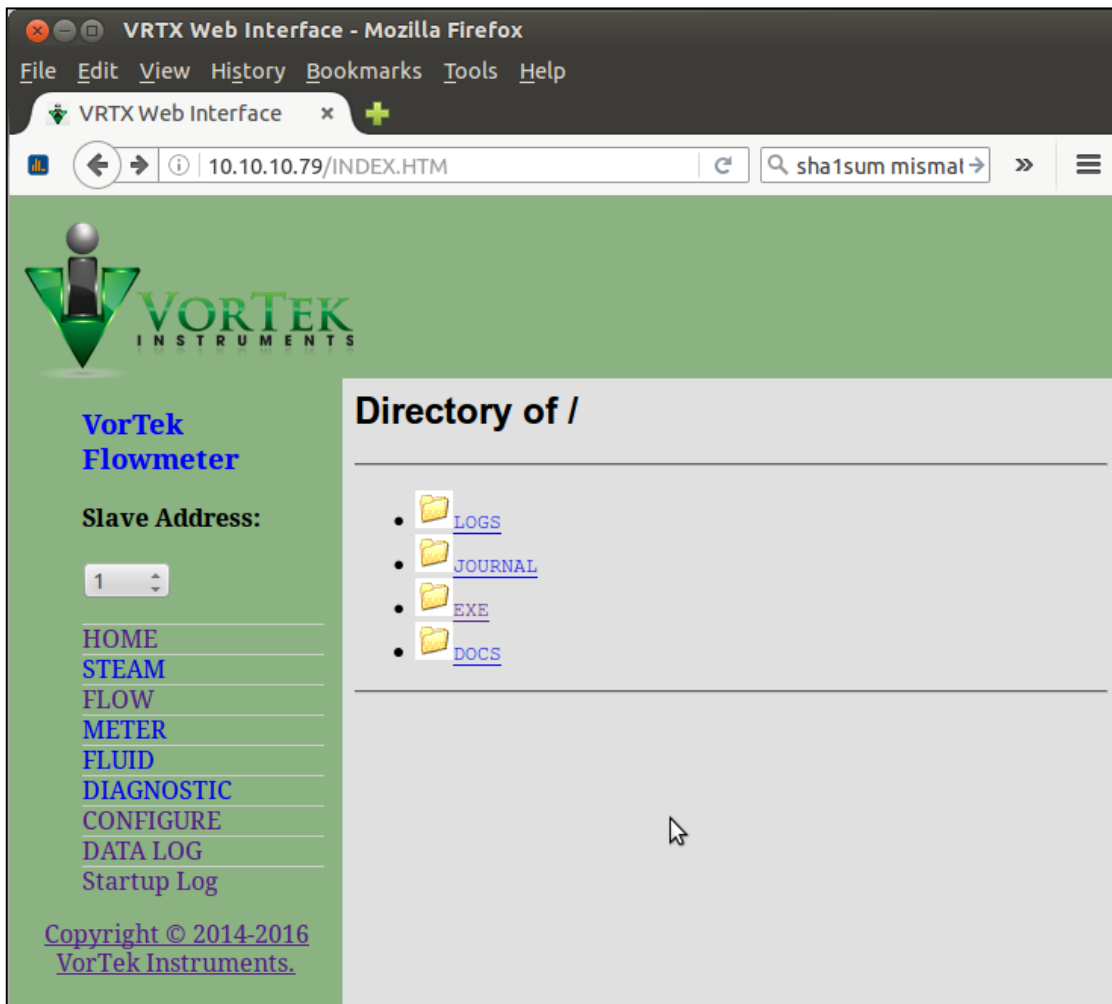

Figure: Data Log Menu



VorTek Instruments, LLC
8475 West I-25 Frontage Rd., Suite 300
Longmont, CO 80504
Phone: (303) 682-9999
Fax: (303) 682-4368
www.vortekinst.com

The following folders are in the Data Log Menu:

- LOGS Contains Log files
- JOURNAL Log files of unit on/off states as well as operator's actions.
- EXE Folder with several executables
- DOCS Documentation

Log files are arranged as a tree:

LOGS

2016 - Year

01 - month

02 - February

...

05 - May

160501.CSV

160502.CSV - Daily files in Comma Separated Variables text format.

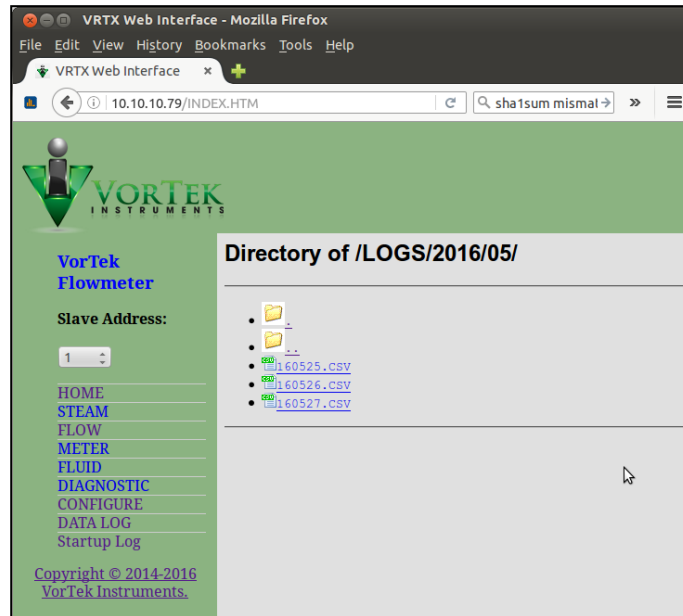

Figure: Log Files



VorTek Instruments, LLC
8475 West I-25 Frontage Rd., Suite 300
Longmont, CO 80504
Phone: (303) 682-9999
Fax: (303) 682-4368
www.vortekinst.com

To download file to your PC right click on it and select “save”. You may also open it immediately. It will be opened as text file or in EXCEL depending on your settings of used browser. You may change it – consult HELP of used browser to find out how to configure default application for file extension .CSV.

Normally, browser asks what to do with this file extension

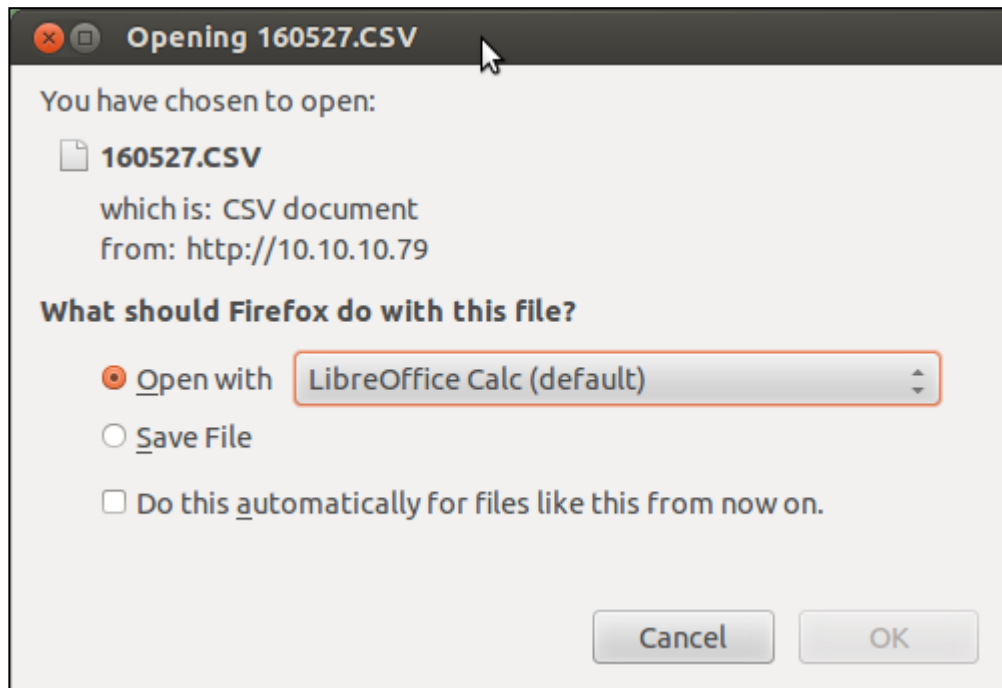

Figure: CSV log file



VorTek Instruments, LLC
 8475 West I-25 Frontage Rd., Suite 300
 Longmont, CO 80504
 Phone: (303) 682-9999
 Fax: (303) 682-4368
 www.vortekinst.com

In this example it is offering to open the file in LibreOffice Calc – analog of Windows EXCEL. It then asks about details of CSV format: what to use as field separators. Select “comma”

Click OK and it will open the file in EXCEL (CALC)

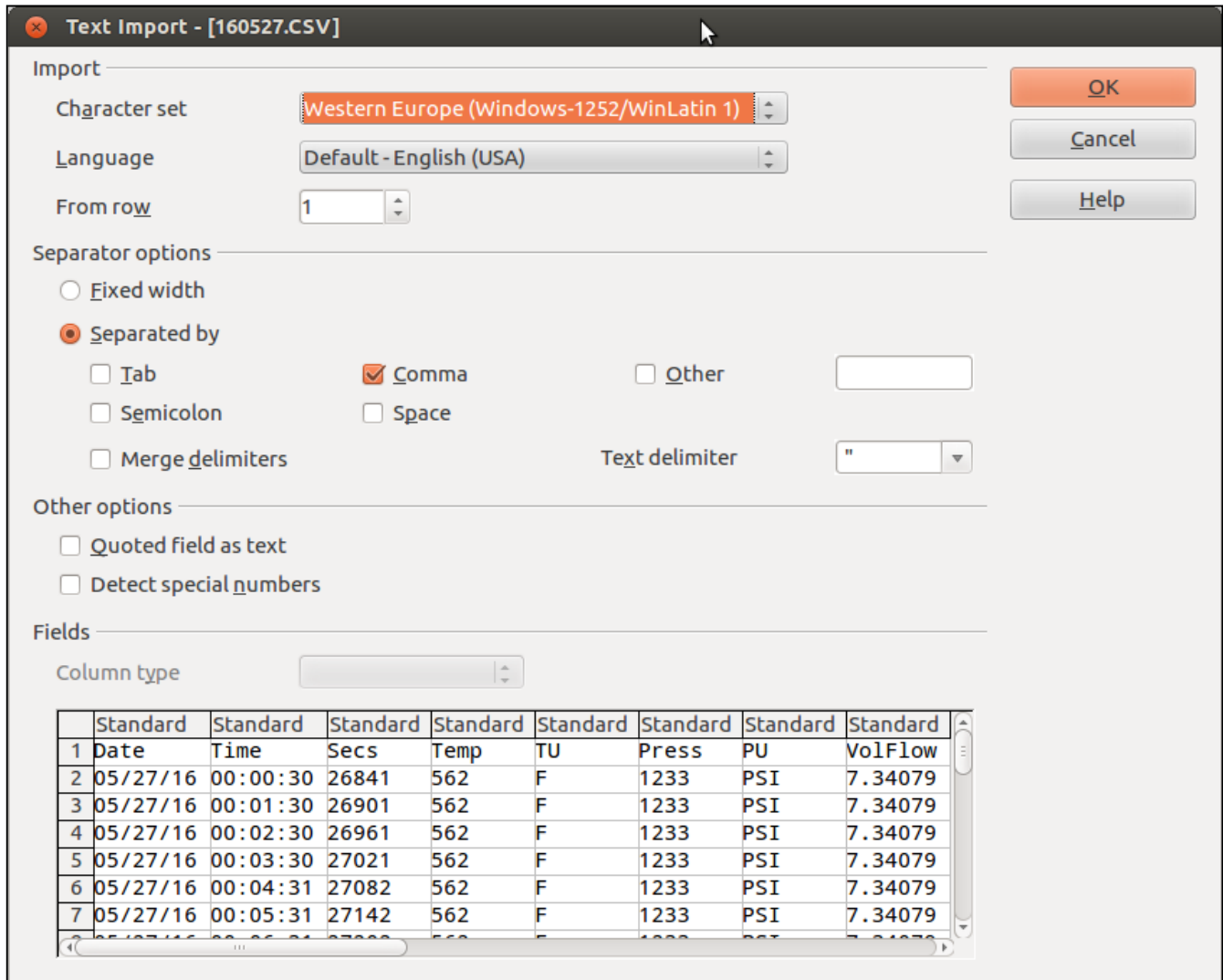

Figure: Text Import file

First three columns in table A, B, and C are fixed and always present. All other are configurable on SD Log Config page on CONFIGURE form.



VorTek Instruments, LLC
 8475 West I-25 Frontage Rd., Suite 300
 Longmont, CO 80504
 Phone: (303) 682-9999
 Fax: (303) 682-4368
 www.vortekinst.com

The names of columns are self-explanatory. Column C (Secs) shows number of seconds since meter was restarted. Columns named PU, TU, VFU display Pressure, Temperature, Volume Flow Units accordingly. New header is output whenever operator changes the list of logged items. Log interval is set on configuration page and can vary from as low as 5 seconds to whatever you choose.

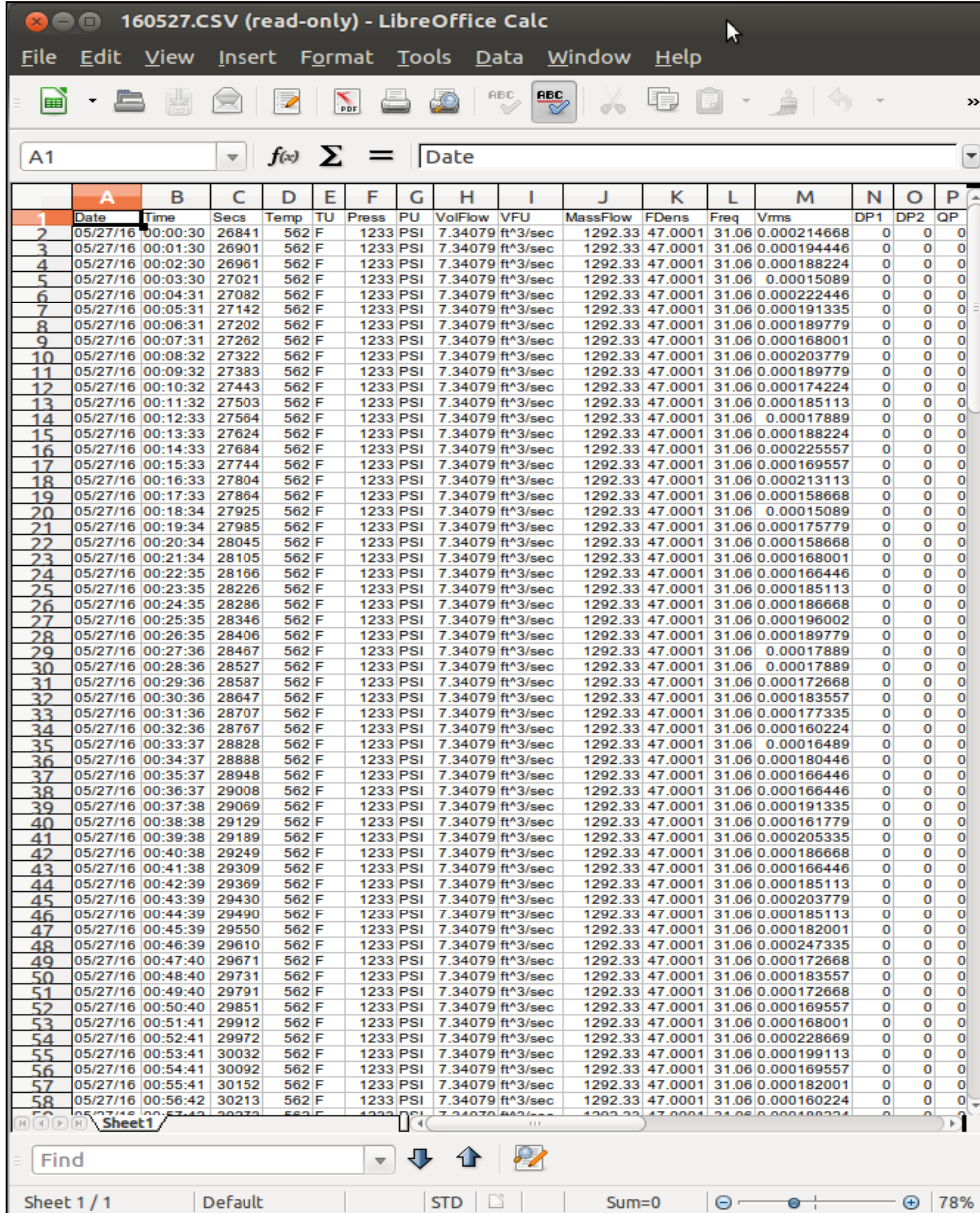

Figure: LibreOffice Calc Example



VorTek Instruments, LLC
8475 West I-25 Frontage Rd., Suite 300
Longmont, CO 80504
Phone: (303) 682-9999
Fax: (303) 682-4368
www.vortekinst.com

The SD Log Config page is the following. Just select desired items and click SET button at the bottom of the form.

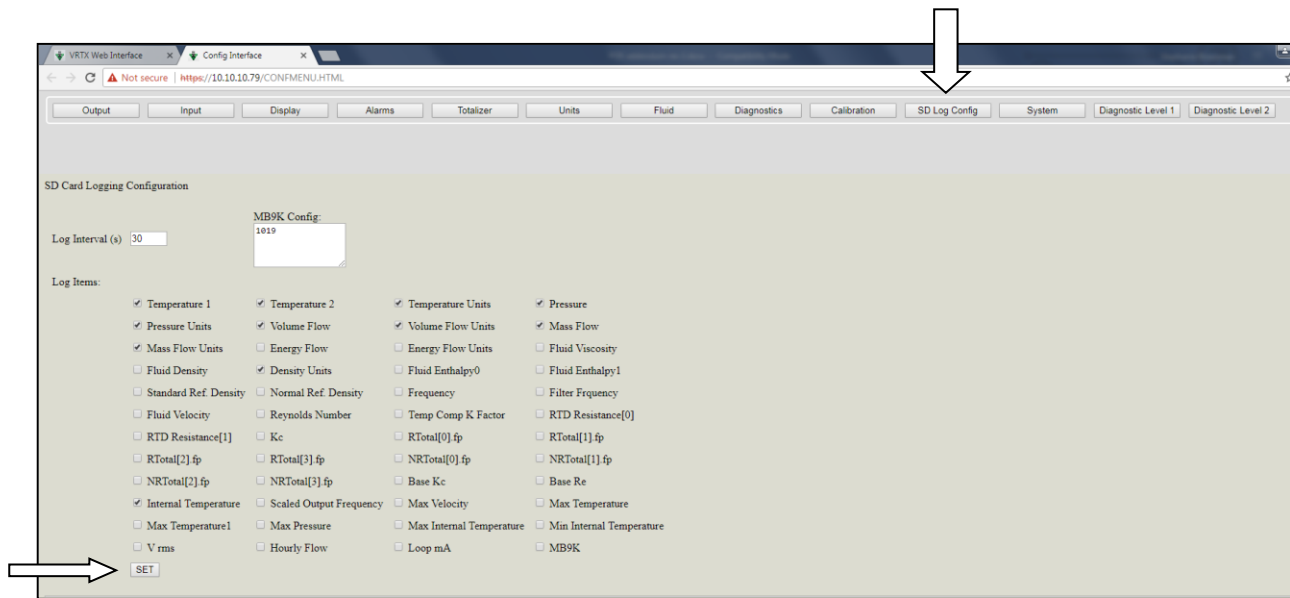

Figure: SD Card Configuration Page

Dummy registers group 9000

Client can read and write into Dummy Modbus registers 9000 to 9999. These registers may be used for storing some process variables and logged synchronously with other VRTX Meter data.

Text area MB9K Config contains configuration of Dummy Modbus registers logging. Line beginning with “#” are comments and not used anywhere. The format of line:

offset, number of items, forms

If MB9K check box at the bottom is selected, logger will add to the end of log line items described in MB10K Config. Each line describes group of Dummy registers in Modbus regs 9000 to 9999.

In each line *offset* is position of the group in 9000 registers. *Number of items* is either number of registers in the group in case of 16 bit values or number of pairs of registers in case of Long and Float formats. *Format* is one character specifying format of items in the group:

- i 16 bit signed integer
- I 16 bit unsigned integer
- l 32 bit signed integer



VorTek Instruments, LLC
 8475 West I-25 Frontage Rd., Suite 300
 Longmont, CO 80504
 Phone: (303) 682-9999
 Fax: (303) 682-4368
 www.vortekinst.com

- L 32 bit unsigned integer
- f 32 bit floating point values

Customer may write into these registers with Function code 16 and read with Function codes 3 and 4. *Note: the contents of these registers is not retained at cycling the power.* The registers in Log file are named as Mxxx for “i” format, MxxxL for “l” format and Mxxx f for “f” format. Where xxx is register offset from 10000. All Dummy registers are in “reversed” format. Most significant word (MSW) is coming first.

MB8K log selector. If checked it will log Dummy registers 9000 according to format specifiers entered in M9K Config area.

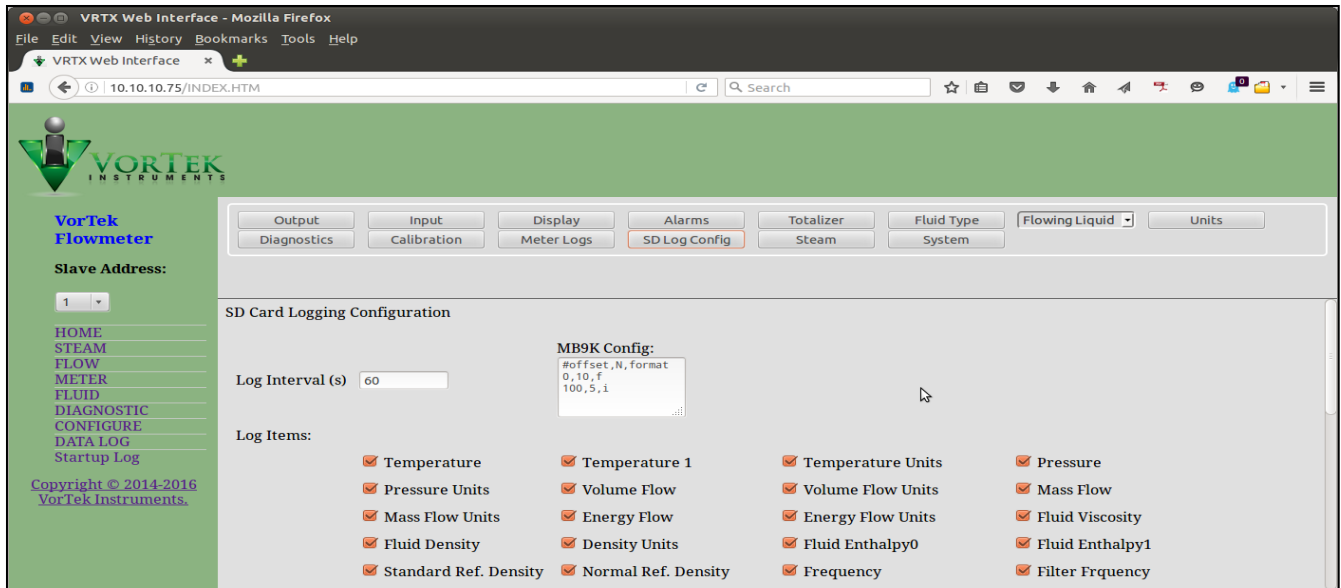

Figure: MB9K Config example



VorTek Instruments, LLC
 8475 West I-25 Frontage Rd., Suite 300
 Longmont, CO 80504
 Phone: (303) 682-9999
 Fax: (303) 682-4368
 www.vortekinst.com

Example of Dummy registers log.

	A	B	C	D	E	F	G	H	I	J	K	L	M	N	O	P	Q	R	S	T	U
1	Date	Time	Secs	Temp	Temp1	TU	M100	M101	M102	M103	M104	M100	M101	M350L	M352L	M600f	M602f	M604f			
2	06/24/16	14:58:01	79	-412.35	30.9231	F	0	0	0	0	0	0	0	0	0	0	0	0	0	0	0
3	06/24/16	14:58:22	100	-412.35	30.9405	F	0	0	0	0	0	0	0	0	0	0	0	0	0	0	0
4	06/24/16	14:58:42	120	-412.35	30.939	F	0	0	0	0	0	0	0	0	0	0	0	0	0	0	0
5	06/24/16	14:59:02	140	-412.35	30.9506	F	-1	2	3	4	5	65535	2	0	0	0	0	0	0	0	0
6	06/24/16	14:59:22	160	-412.35	30.9339	F	-1	2	3	4	5	65535	2	0	0	0	0	0	0	0	0
7	06/24/16	14:59:43	181	-412.35	30.9412	F	-1	2	3	4	5	65535	2	0	0	0	0	0	0	0	0
8	06/24/16	15:00:03	201	-412.35	30.9463	F	-1	2	3	4	5	65535	2	0	0	0	0	0	0	0	0
9	06/24/16	15:00:23	221	-412.35	30.9281	F	-1	2	3	4	5	65535	2	0	0	0	0	0	0	0	0
10	06/24/16	15:00:43	241	-412.35	30.9058	F	-1	2	3	4	5	65535	2	0	0	0	0	0	0	0	0
11	06/24/16	15:01:04	262	-412.35	30.9405	F	-1	2	3	4	5	65535	2	0	0	0	0	0	0	0	0
12	06/24/16	15:01:24	282	-412.35	30.939	F	-1	2	3	4	5	65535	2	0	0	0	0	0	0	0	0
13	06/24/16	15:01:44	302	-412.35	30.9376	F	-1	2	3	4	5	65535	2	0	0	0	0	0	0	0	0
14	06/24/16	15:02:04	322	-412.35	30.9463	F	-1	2	3	4	5	65535	2	0	0	0	0	0	0	0	0
15	06/24/16	15:02:24	342	-412.35	30.9347	F	-1	2	3	4	5	65535	2	0	0	0	0	0	0	0	0
16	06/24/16	15:02:45	363	-412.35	30.9426	F	-1	2	3	4	5	65535	2	0	0	0	0	0	0	0	0
17	06/24/16	15:03:05	383	-412.35	30.9426	F	-1	2	3	4	5	65535	2	0	0	0	0	0	0	0	0
18	Date	Time	Secs	Temp	Temp1	TU	Press	PU	VolFlow	VFU	MassFlow	MFU	FDens	DU	Freq	Re	Kf	MaxT	DP1	DP2	DP3
19	06/24/16	15:03:25	403	-412.35	30.9281	F	0	PSI	885.616	ft ³ /sec	1.06443e+06	lb/sec	149.849	lbm/ft ³	400	3.46721e+06	202.72	-40	0	0	0
20	06/24/16	15:03:45	423	-412.35	30.9281	F	0	PSI	885.616	ft ³ /sec	1.06443e+06	lb/sec	149.849	lbm/ft ³	400	3.46721e+06	202.72	-40	0	0	0
21	06/24/16	15:04:06	444	-412.35	30.9383	F	0	PSI	885.616	ft ³ /sec	1.06443e+06	lb/sec	149.849	lbm/ft ³	400	3.46721e+06	202.72	-40	0	0	0
22	06/24/16	15:04:26	464	-412.35	30.9303	F	0	PSI	885.616	ft ³ /sec	1.06443e+06	lb/sec	149.849	lbm/ft ³	400	3.46721e+06	202.72	-40	0	0	0
23	06/24/16	15:04:46	484	-412.35	30.9535	F	0	PSI	885.616	ft ³ /sec	1.06443e+06	lb/sec	149.849	lbm/ft ³	400	3.46721e+06	202.72	-40	0	0	0
24	06/24/16	15:05:06	504	-412.35	30.9383	F	0	PSI	885.616	ft ³ /sec	1.06443e+06	lb/sec	149.849	lbm/ft ³	400	3.46721e+06	202.72	-40	0	0	0
25	06/24/16	15:05:26	524	-412.35	30.9318	F	0	PSI	885.616	ft ³ /sec	1.06443e+06	lb/sec	149.849	lbm/ft ³	400	3.46721e+06	202.72	-40	0	0	0
26	06/24/16	15:05:47	545	-412.35	30.9361	F	0	PSI	885.616	ft ³ /sec	1.06443e+06	lb/sec	149.849	lbm/ft ³	400	3.46721e+06	202.72	-40	0	0	0

Figure: Dummy register log example

Other methods of retrieving log files

WGET

Retrieving log files could be automated using Internet-standard utility WGET. This utility readily available on Linux machines and for Windows can downloaded from here:

<https://www.gnu.org/software/wget/> or install Linux simulator on Windows WinBash, which also contains WGET: <http://win-bash.sourceforge.net/>

To read daily file for specific date use the following WGET command:

WGET <http://10.10.10.79/LOGS/2016/05/160527.CSV> (where first 2 digits – year, next – month, next day). This instruction will download daily log file for date: 05/27/2016



VorTek Instruments, LLC
8475 West I-25 Frontage Rd., Suite 300
Longmont, CO 80504
Phone: (303) 682-9999
Fax: (303) 682-4368
www.vortekinst.com

FTP

VRTX/TCP meter has capability of accessing the file system on SD card via FTP protocol. For that you may use any specialized FTP client or even File browser on Linux or Windows systems.

In Windows Explorer enter in address field <ftp://10.10.10.79/> or whatever is IP of your meter. You may be asked first time for the User Name and Password. Use User: “owner” and Password: “16363”. You'll get almost full access to the file system on SD card. You may copy files, delete files and directories. Creating directories is not allowed.

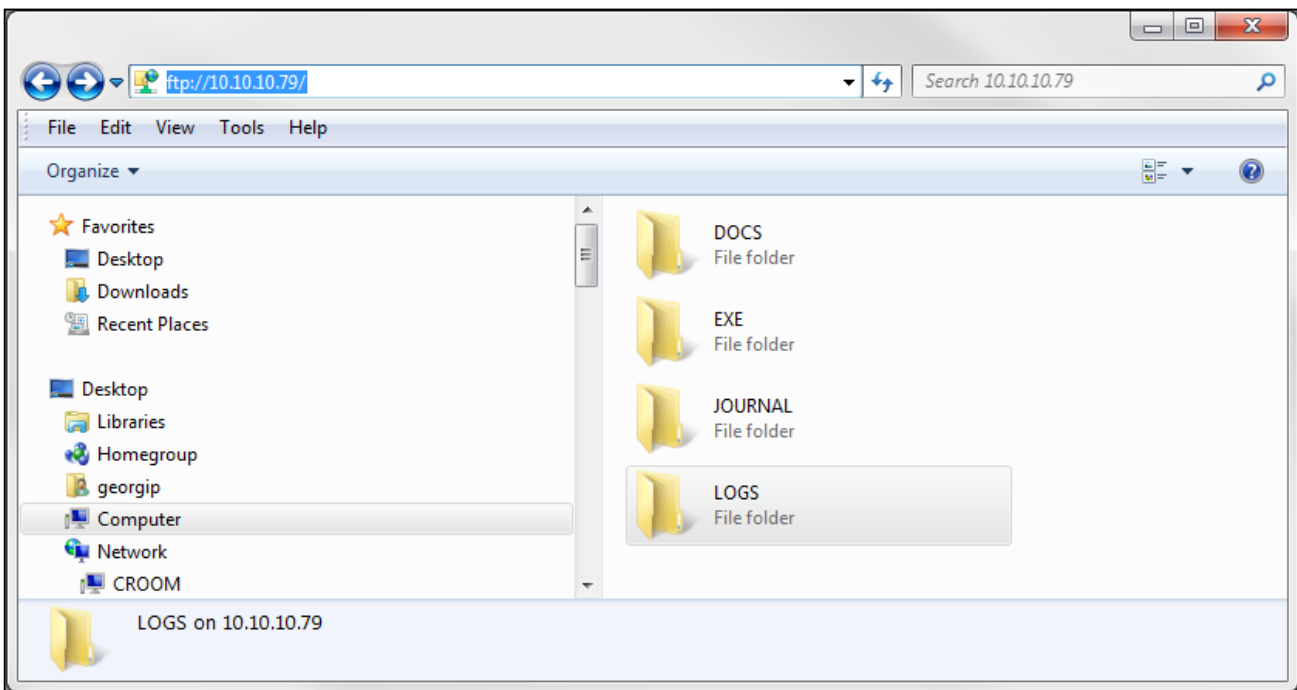

Figure: FTP example

FTP access may be automated with mentioned above WGET application. The string to query single file is the following: WGET <ftp://owner:16363@10.10.10.79/LOGS/2016/05/160527.CSV>
(Note how to supply user name and password when accessing via FTP.)

Note: You may use FTP access to clean SD card by removing unnecessary data or wrong directories created due to misread Real Time Clock of the meter.



VorTek Instruments, LLC
8475 West I-25 Frontage Rd., Suite 300
Longmont, CO 80504
Phone: (303) 682-9999
Fax: (303) 682-4368
www.vortekinst.com

Update of Firmware

VORTEX meter firmware can be updated on-line. For that there are two applications:

- AutoUpdate Standard update utility using UDP protocol. Local network only.
- TcpUpdate Update utility using TCP protocol allowing access from other networks.

In revision 1.0 of VORTEX/TCP TcpUpdate is disabled. AutoUpdate should always be used.

The AutoUpdate application can be downloaded from EXE directory on SD file system of the unit.

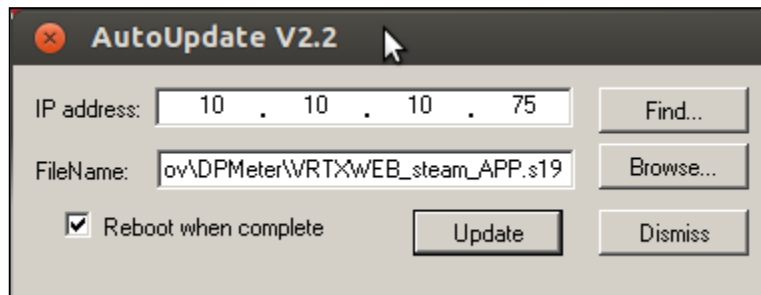

Figure: AutoUpdate

Usage is simple: enter IP address of you meter (or find meter on the local network).

Browse for provided by VortekInst application file in xxx_APP.s19 format.

Click update. That's it.

Update with TcpUpdate is the same, except FIND may not work across routers/switches.